

DYMO[®]

LabelWriter[®] 450 Twin Turbo

Quick Start Guide



LabelWriter 450 Twin Turbo

Copyright

© 2009 Sanford, L.P. All rights reserved. Revised 4/09.

No part of this document or the software may be reproduced or transmitted in any form or by any means or translated into another language without the prior written consent of Sanford, L.P.

Trademarks

DYMO, DYMO File, DYMO Stamps, LabelWriter, and DYMO Label are trademarks or registered trademarks of Sanford, L.P. All other trademarks are the property of their respective holders.

LabelWriter®

Quick Start Guide

Follow these steps to install the LabelWriter printer and print your first label.

1. Unpacking your LabelWriter Printer

NOTE Do not plug the printer into your computer until after the software installation is complete.

- 1 Unpack your printer and save the packing materials.
- 2 Make sure you have all the items shown in Figure 1. (Labels included in the package may vary.)

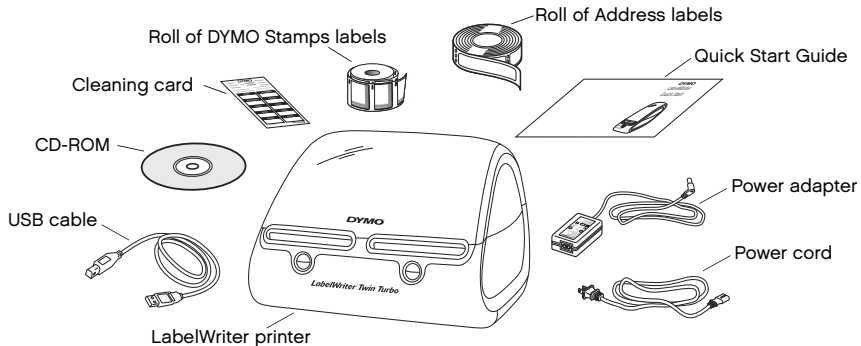

Figure 1

Become familiar with the printer's major components. See Figure 2.

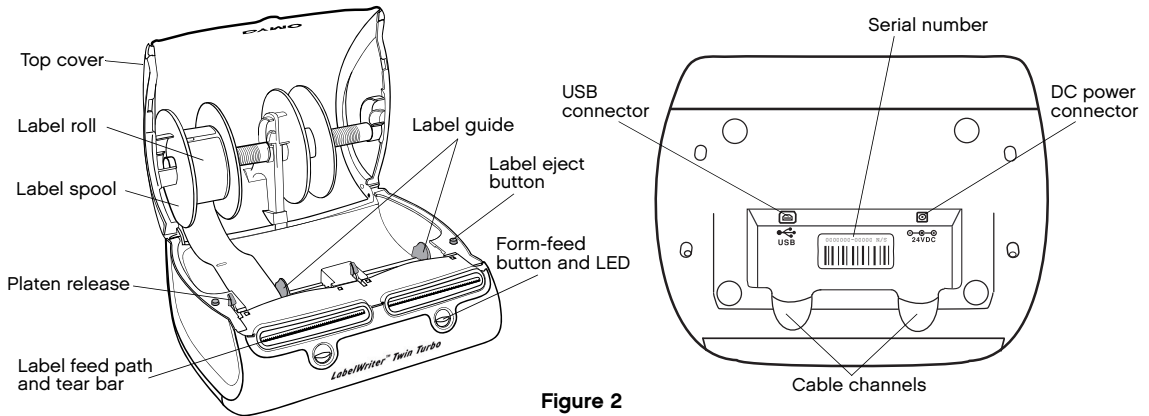

Figure 2

LabelWriter Printer Features

Your LabelWriter printer is a direct thermal printer and does not use ink or toner. Instead, the printer uses heat from a thermal print head to print on specially treated labels. Labels are the only supplies you will ever need to buy.

The form-feed button on the front of the printer advances a single label. The label eject button is used to remove labels from the printer when changing rolls.

The status light visually shows the current state of the printer:

- Solid blue - power is on and the printer is ready.
- Flashing blue - labels are not loaded properly or the label roll is empty.
- Dimmed blue - printer is in power saving mode.

2. Installing the Software

Do not connect the printer to your computer until after the software installation is complete.

Windows Depending on your system configuration, the software installation could take some time while the required Microsoft .NET™ software is installed.

To install the software on a Windows system

- 1 Close all open Microsoft Office applications.
- 2 Insert the DYMO Productivity Software CD into your CD-ROM/DVD drive.
After a few seconds, the installation screen appears.
- 3 Click Install and follow the instructions in the installer.

QuickBooks If you have QuickBooks 2007 or later, you will be prompted to install the QuickBooks Add-in.

You will be prompted to install DYMO File software after DYMO Label software. You can choose not to install DYMO File by clearing the check box during the installation. See www.dymofile.com for information about DYMO File software.

To install the software on a Mac OS system

- 1 Insert the DYMO Productivity Software CD into the CD-ROM/DVD drive.
After a few seconds, the DYMO Label Installer icon appears.
- 2 Double-click the Installer icon and follow the instructions.

3. Connecting your LabelWriter Printer

NOTE Do not connect the printer to your computer until after the software installation is complete.

To connect the power

- 1 Plug the power cord into the power adapter. See Figure 3.
- 2 Plug the power adapter into the power connector on the bottom of the printer. See Figure 4.
- 3 Plug the other end of the power cord into a power outlet.
- 4 Plug the USB cable into the USB port on the bottom of the printer.
- 5 Insert the power and USB cables through the cable channel and set the printer down.
- 6 When the software is completely installed, connect the other end of the USB cable into an available USB port on your computer.

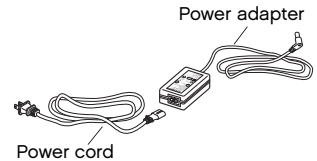

Figure 3

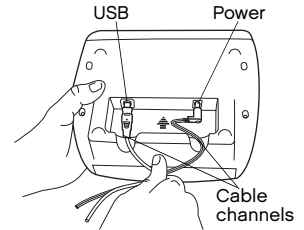

Figure 4

Mac OS If the printer is not in the printer list when the installation is complete, refer to the ReadMe file for instructions on how to add the printer.

4. Loading Labels

The LabelWriter Twin Turbo printer holds two label rolls, so you can print two types of labels without having to change the label roll. For example, load address labels on one side and DYMO Stamps postage labels on the other side.

Important!

In order for the labels to feed properly during printing, pay attention to the following when loading labels on the spool and into the printer:

- The label spool guide must be pushed flush against the label roll, with no gap. See Figure 6.
- The labels must be loaded with the left edge of the label inserted against the left edge of the label feed slot. See Figure 8.

To load a label roll

- 1 Press the form-feed button to eject the labels that protected the printer during shipment.
- 2 Open the top cover and remove any packing material inside the label compartment.
- 3 Remove the label spool on the left from inside the top cover and pull the spool guide from the spindle.
- 4 Hold the spool spindle in your left hand and place the label roll on the spindle so that the labels feed from underneath and the left edge of the label roll is firmly against the side of the spool. See Figure 5.

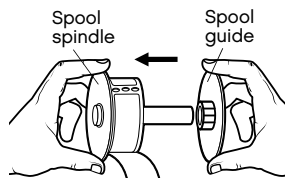

Figure 5

- Slide the spool guide onto the right side of the spool and press the guide tightly against the side of the label roll, **leaving no gap** between the roll and the spool. See Figure 6.

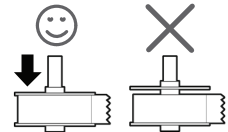

Figure 6

- Insert the label spool into the left slot in the printer cover with the labels extending from underneath the roll. See Figure 7.
- Align the left edge of the label with the left edge of the label feed slot and insert the label into the slot. See Figure 8.

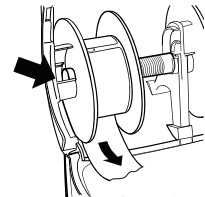

Figure 7

The printer automatically feeds the label, stopping at the beginning of the first label.

If the printer does not feed the labels, make sure the first label is fully inserted and then press the form-feed button.

If the first label on the roll is not a full label, press the form-feed button to eject the partial label.

- Slide the label guide to the left until the label guide aligns with the right edge of the label. See Figure 8.

Make sure that the label guide does not pinch the label.

- Repeat steps 3-8 to load labels on the right side of the printer.
- Carefully lower the top cover.

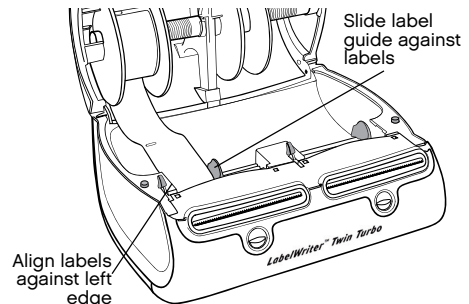

Figure 8

5. Printing your First Label

The first time you open the application, you are asked to register the software. Registering the software ensures that you will be informed of any software updates.

During the registration process, you will be asked to enter the serial number for your label printer. The serial number is located on the bottom of the printer.

To print your first label

- 1 Start DYMO Label software by doing one of the following:
 - For Windows, click **Start**, then **Programs>DYMO Productivity Software>DYMO Label**.
 - For Macintosh, double-click the DYMO Label icon in the **Applications** folder.

The first time you start DYMO Label software, a list of available label types is displayed on the left side of the window and an address label is displayed in the Edit area.



- 2 Click once on the address label in the Edit area and type some text.
- 3 Optionally, choose a font and a justification setting from the **Formatting** toolbar.
- 4 If necessary, click  and then click  to choose the side of the printer that has address labels loaded.
- 5 Click  to print the label.

Figure 9 highlights some of the major features available in DYMO Label software.

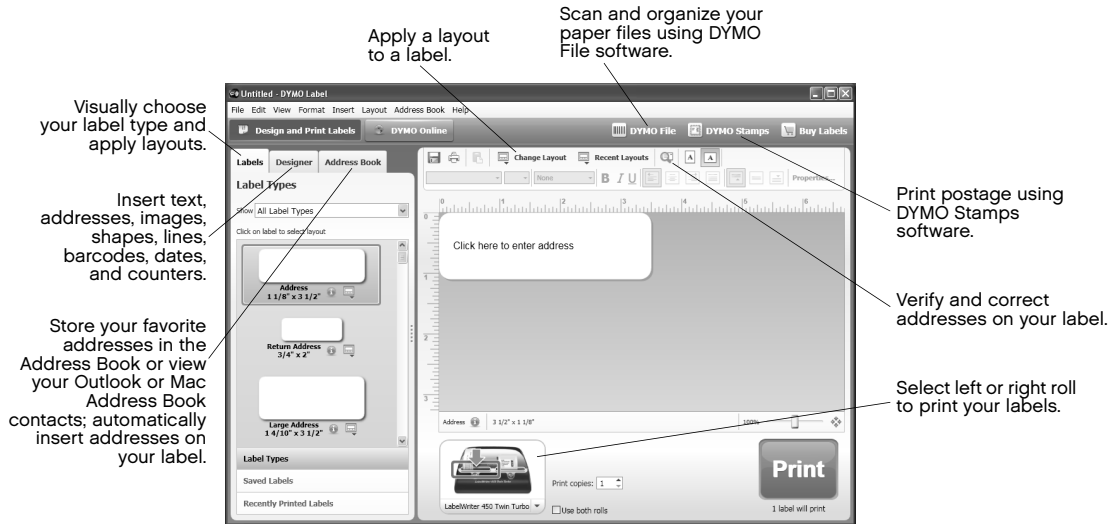

Figure 9

For complete details on using the software, refer to the online Help.



For Windows Only

Quick Start Guide

With DYMO File software, you can scan and organize your paper files. For complete information about DYMO File, visit www.dymofile.com.

You were prompted to install DYMO File as part of the DYMO Label software installation. If you chose not to install DYMO File, you can install it now.

To install DYMO File software

- 1 Insert the DYMO Productivity Software CD into your CD-ROM/DVD drive.
- 2 Locate the **DYMO File** folder on the CD.
- 3 Double-click **DYMOFILE203.exe** and follow the instructions in the installer.

The process to configure and start using your DYMO File software includes these steps:

- Activating DYMO File software
- Setting up your printer and scanner
- Scanning your first document

1. Activating DYMO File Software

When you open DYMO File, you are asked to activate the software with the Product Key located on the DYMO Productivity Software CD sleeve.

To activate DYMO File software

- 1 Click **Start > Programs > DYMO File > DYMO File**.
- 2 Select **Activate DYMO File with Product Key**.
- 3 Do one of the following:
 - Select **Activate automatically over the Internet**.
 - Select **Activate manually by phone**, follow the instructions provided by Customer Support, and then continue with *2. Setting Up Your Printer and Scanner*.
- 4 Enter the **Product Key** located on the DYMO Productivity Software CD sleeve, and then click **Submit**.
- 5 Click **OK** on the **Activation completed successfully** message.

2. Setting Up Your Printer and Scanner

The first time DYMO File starts, the DYMO File First Run Wizard appears and guides you through the following steps:

- Selecting your LabelWriter printer to print barcodes
- Selecting and setting up your scanner
- Selecting a folder to monitor for scanned documents
- Testing your configuration

NOTE You can use the First Run Wizard to make changes at any time. The First Run Wizard is available from the Tools menu in DYMO File.

To set up your printer and scanner

- 1 In the wizard, click **Next** and follow the on-screen instructions to set up your printer and scanner and to test your configuration.
- 2 Watch the one-minute Getting Started video for an overview of scanning your first document.
- 3 At the end of the wizard, complete the registration information in the **Register** dialog box and click **Register Now**.

3. Scanning Your First Document

When using DYMO File software, your documents are organized as you scan them. You create a reservation file with the name you want your scanned document to have and in the folder where you want the document to be saved.

Then, using a special barcode, the scanned document is recognized and the corresponding reservation file is replaced with that document.

To create a reservation and scan your first document

- 1 Under **Filing Location**, select a folder for filing your document.
This folder is where your scanned document will be saved.
- 2 Under **Document Information**, do the following:
 - a. Enter the name for the scanned document in the **File name** field.
 - b. Select the format for the scanned document from the **Save as type** list.

- 3 Under **Barcode**, select one of the following:
 - **Label** to print a barcode label on a LabelWriter printer.
 - **Cover Sheet** to print a cover sheet with a barcode on a standard printer. Select this option if you do not want the barcode to show on the scanned document.
- 4 Click **Create Reservation** to create a document reservation file in the folder you selected and print the barcode.
- 5 Attach the barcode label to your document or place the barcode cover sheet as the first page of the document you want to scan.
- 6 Do one of the following, depending on the scanner you use:
 - Network scanner: Scan the document using the settings for DYMO File that were specified in the scanner software during the First Run Wizard.
 - Local scanner: In DYMO File, click the **Scan** button on the **Scan** tab, and then scan the document.

After a few moments, the reservation file is replaced by your scanned document.

This figure shows filing and scanning steps and highlights other major features of DYMO File.

Find documents previously filed on your computer.

See which documents are waiting to be scanned.

Quickly file documents in a few easy steps.

With a local scanner, use this tab to scan.

Use filing templates to quickly create a set of folders and document reservations.

The screenshot shows the DYMO File application window. The menu bar includes File, Edit, View, Tools, and Help. The toolbar contains buttons for Reserve, Scan, Find, and Status (3 Reservations). The main window is titled 'To create a document reservation: select the folder in which you want to save your document, name the document, then click the Create Reservation button. Apply the printed barcode before scanning the document.' The interface is divided into several sections: 'Filing Location' with a file explorer view showing 'My Documents' selected; 'Document Information' with fields for 'File name' and 'Save as type' (set to 'Adobe Acrobat (*.pdf)'); 'Barcode' options for 'Label' and 'Cover Sheet'; and a 'Create Reservation' button. A status bar at the bottom indicates '3 of 800 pages scanned in March'.

Step 1. Choose your filing location.

Step 2. Name your document and select the type of file to save.

Step 3. Print a barcode label or cover sheet and create a document reservation.

Step 4. Attach the barcode and scan your document, now or later.

For complete details about using the software, see the DYMO File online Help. For more information on DYMO File software, visit www.dymofile.com.



Printing Postage with DYMO Stamps

You can now print postage right from your desktop using your LabelWriter Twin Turbo label printer. All you need is DYMO Stamps software, your LabelWriter printer, DYMO Stamps labels, and an Internet connection.

To install DYMO Stamps and print postage

- 1 Sign up for your USPS account with Endicia. Go to: www.endicia.com/dymostamps
- 2 At the end of the sign up process, download and install the DYMO Stamps software.

DYMO Stamps software is available for both Windows and Mac OS X.

NOTE You must have DYMO Label software and your LabelWriter printer installed before installing the DYMO Stamps software.

The first time you start the DYMO Stamps software, you are prompted to enter the postage account number assigned and the pass phrase you created during the sign-up process.

- 3 Enter your account number and pass phrase, and then click **OK**.

Account Preferences

Account Settings

Account Number: 955555

Pass Phrase: ●●●●●●●●

Make Pass Phrase visible

Remember Pass Phrase

Change Pass Phrase Advanced

Postage Warning Limit

Confirm printing when postage total exceeds: \$4.00

OK Cancel

- 4 Click  **Buy Postage** and purchase postage for your account.
- 5 Select **DYMO LabelWriter Twin Turbo** from the **Printer** list under **Printer Selection**.
- 6 Select **Right Roll** or **Left Roll** from the **Label Roll** list, depending on where you have DYMO Stamps postage labels loaded.
- 7 Click **Test Print** to print a voided postage label.

You are now ready to start printing actual postage whenever you need it. Refer to the DYMO Stamps online Help for more information about using the software.

You can add postage, buy DYMO Stamps postage labels, and order supplies directly from within the DYMO Stamps software.

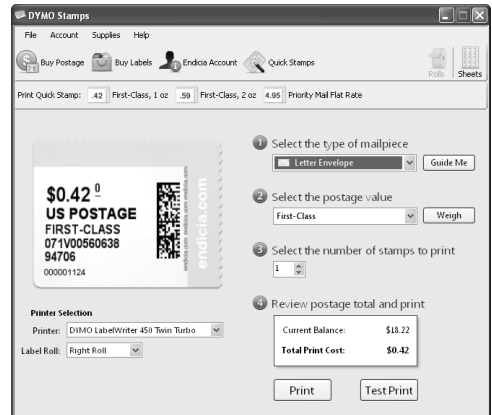

DYMO[®]

A ***NewellRubbermaid*** Company

Produced by:
DYMO, Stamford, CT
800-426-7827: www.dymo.com
© 2008 Sanford, L.P.

1755147, Rev. 4/09